

THE
WOOD FIRED
AUST. MADE
SINCE - CO. - 2012

Precut 850 Brick dome oven
instructions (Round)

V270519

Oven checklist

850 brick dome oven components checklist		
	Qty	Check
300 x 300 x 50mm floor tiles	10	
Chamber bricks		
230 x 115 x 75 IFB	18	
631 brick	54	
632 brick	52	
633 brick	33	
55 x 115 x 75/63	2	
86 x 115 x 75/63	2	
32 x 115 x 75/63	1	
64 x 115 x 75/63	1	
Door arch bricks		
230 x 115 x 25 IFB	2	
230 x 115 x 75/63 rear taper	2	
230 x 115 x 75/51	14	
Flue arch bricks		
230 x 115 x 25mm	2	
230 x 115 x 75/63	4	
230 x 115 x 75/51	8	

Brick trim		
Large stainless steel cap	1	
50mm x 75/51 face	4	
50mm x 75/51 grain	4	
50mm x 75/63 face	2	
50mm x 75/63 grain	2	
230 x 115 x 75/63 F1 (cut taper left and right)	2	
50mm B1 brick	2	
50mm B2 brick	2	
50mm B3 brick	2	
50mm B4 brick	2	
1000 x 600 x 25mm Calsil board	1.5	
20kg Airset mortar	2	
10kg Fondu	1	
7.2 x .610 x 25mm blanket	1	
Chamber templates	4	
Door arch templates	2	
Flue arch templates	2	
Timber spacers	12	
Stainless flue with hat 150mm x 450	1	
Thermometer	1	
1/2 bag castable - 10kg	1	
Door (black standard) or stainless - temp probe	1	

Safety & Tools

Please take care as Sydney Fire bricks take no responsibility for and harm to the builder of the oven.

Extras needed to complete the oven.

- 3 x Bags of yellow brickies sand
- 3 x bags of washed Sydney sand or alternative
- Chicken wire – 5 metre roll
- Galvanised tie wire thin gauge
- 4 x rolls of supermarket aluminium foil
- Trowel
- Gloves, respirator and safety glasses
- Wire cutters
- Pencil
- shovel
- Wheel barrow for fondu mix
- Tape measure
- Stanley knife
- Bucket and sponge
- 8 x common house bricks for plug
- 4 x 2mm spacers (eg 20c pieces)

Helpful items

Paint Scraper

Paint & Rust Stripper Disc

Rubber mallet

Cement cutting disks

Drill with ceramic bits

Tarp or builders plastic to cover during bad weather

Builders plastic to catch debris

Tips and tricks

- When using ceramic fibre wear long sleeves and a mask in case of allergies or irritation.
- The render on top of the ceramic fibre blanket should be 20 -30mm or thicker to have sufficient strength. Use wire mesh for reinforcing.
- Floor tiles should be placed inside **loose (no mortar)** so over time with wear and tear, any cracked or broken tiles may be replaced. Ash after a few uses will fill any gaps and act as an expansion joint. If you mortar them in it will break any undertile product upon removal.
- When laying your floor tiles in position grind any high lips down leaving a smooth joint, this will stop the peel catching on any tiles. The tiles can be grinded on one side then flipped over so the grinded side can face down.
- When using cement fondu thicken it to a mortar consistency with washed sydney sand (3 parts sand / 1 part fondu) to fill the gaps in between gaps bigger than 5mm, the fondu will go off very quickly so act fast.
- The Airset mortar provided should be stirred before use and will go off very quickly if the lid is left off. (this is the White plastic pail)

Type of bricks in your chamber



Layout

Lay your calcium silicate board in the center of the slab and 185mm from the rear of the slab

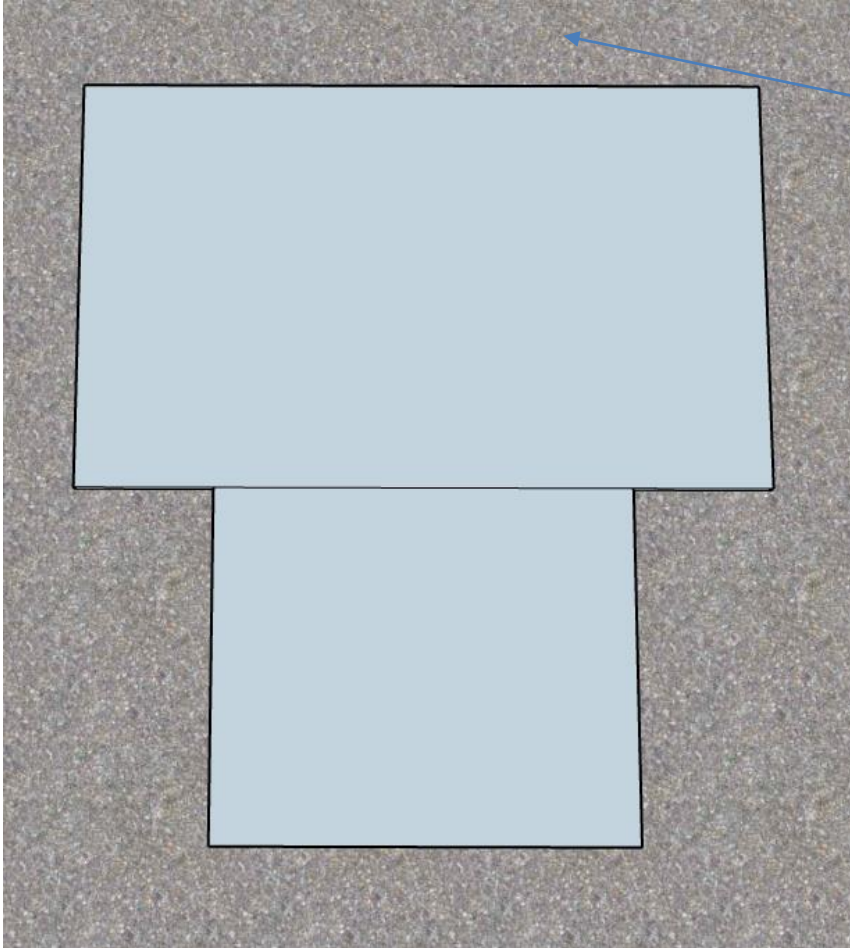

Laying your floor tiles

Starting from the rear edge of the calcium silicate board and in the middle join lay your tiles in the following pattern loosely

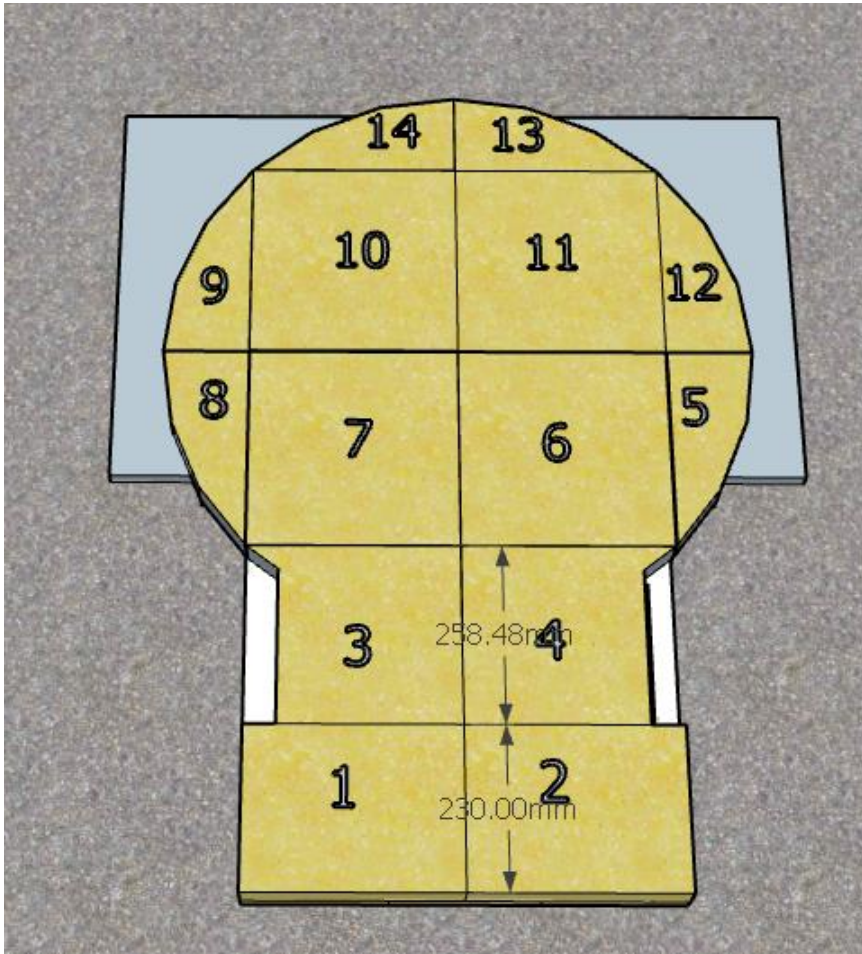

Front floor preparation

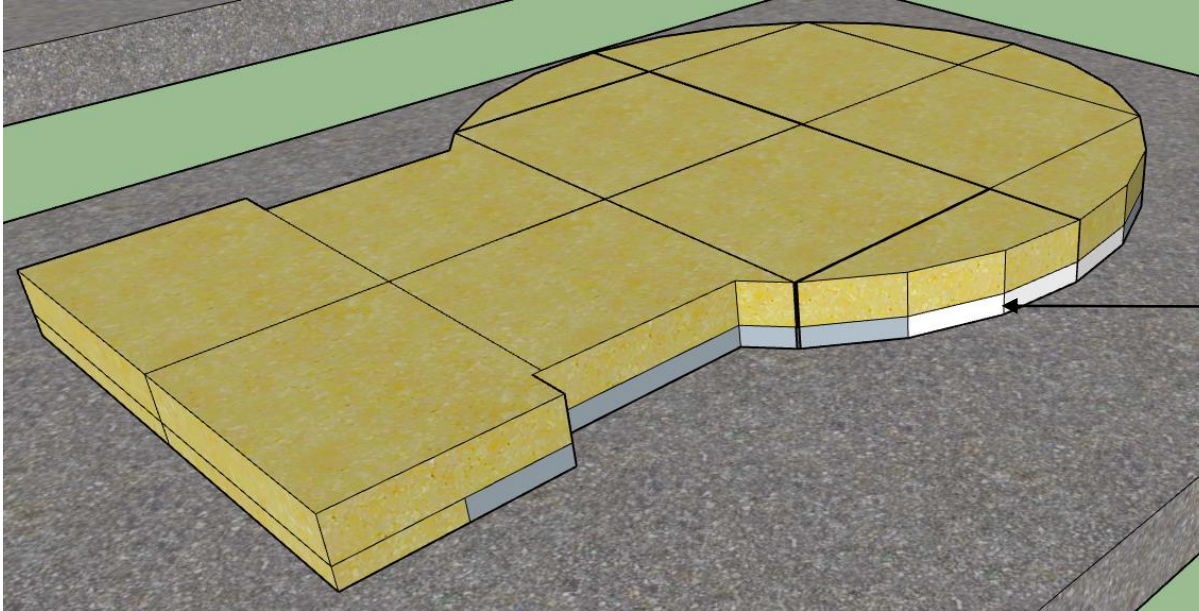

With a handsaw trim around the perimeter of the floor tiles cutting the calcium silicate board flush to the tiles ..

You have your finished floor tiles and now its time to build the chamber..



Don't forget to grind and major lips in the floor tiles to save from your pizza peel getting caught and flip them over so the ground edge faces the insulation board

White IFB brick & door arch layout

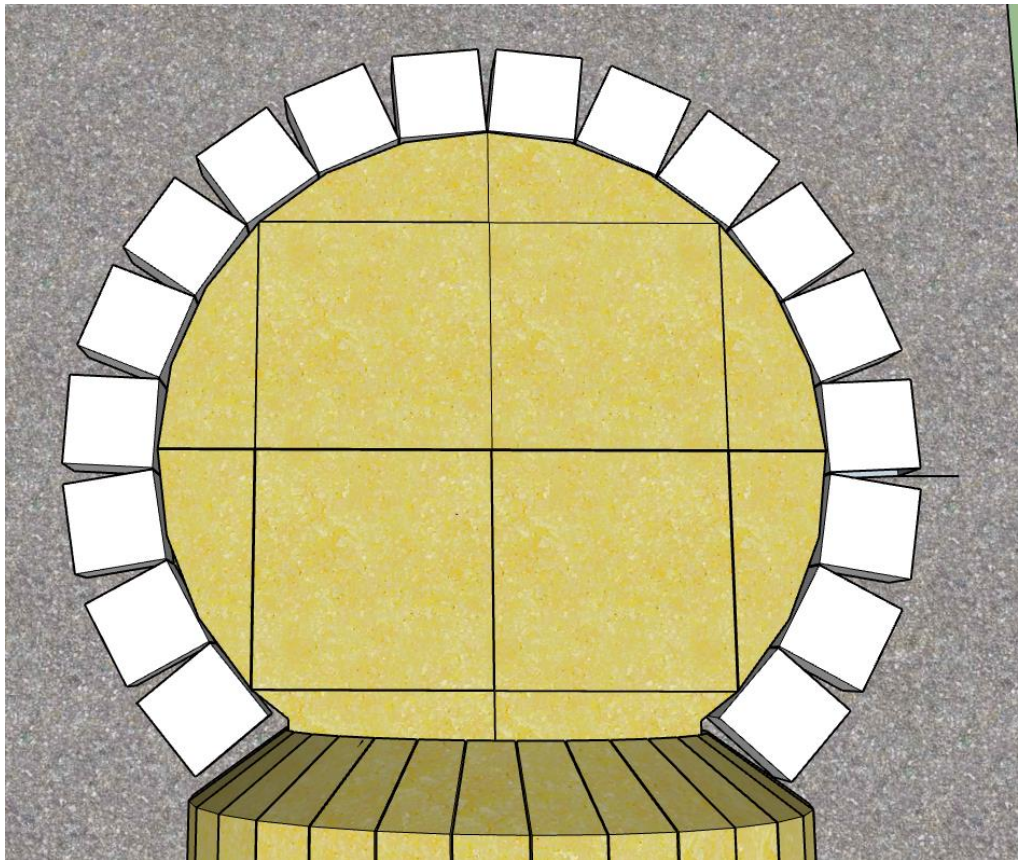

1st course

Your first layer of firebrick on the floor for your chamber consists of a White IFB. This is a strong brick that prevents any heat transfer to the slab. It also is waterproof and will never fail over time in any condition. Calcium silicate boards as a structural layer collapse over time.

Layer your bricks around evenly using the airset mortar tapping them down flat ready for the next layer

Also mortar down and position your door arch supporting bricks to build your door arch, these will end up level with your floor

If you were supplied 50mm Calcium silicate insulation board versus the standard 25mm you will also have 115 x 115 x 25mm IFB insulation brick. These on go on top of the first IFB layer to lift the first IFB layer level with the cooking floor

Door arch template construction

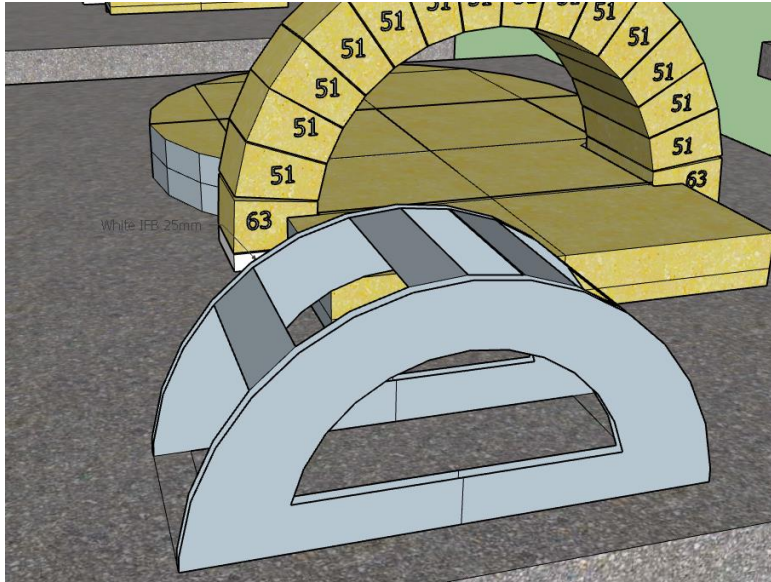

Screw or nail your door arch template (smaller) together using timber at approximately 180mm long - only 6 battens needed.

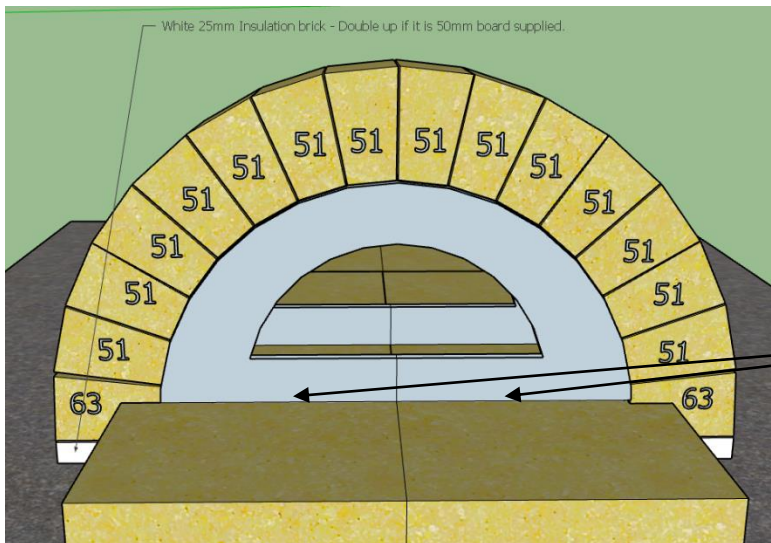

make sure you have placed 4x 2mm or (20c pieces) spacers under the door arch template so it can be removed to make the template drop instead of pulling it out in which may disrupt the bricks.

Building your door arch

To start building your door arch only butter the bricks to 2-3 mm between bricks and Tap down gently.

This will bring your door arch support bricks level

With the bottom of the door arch template

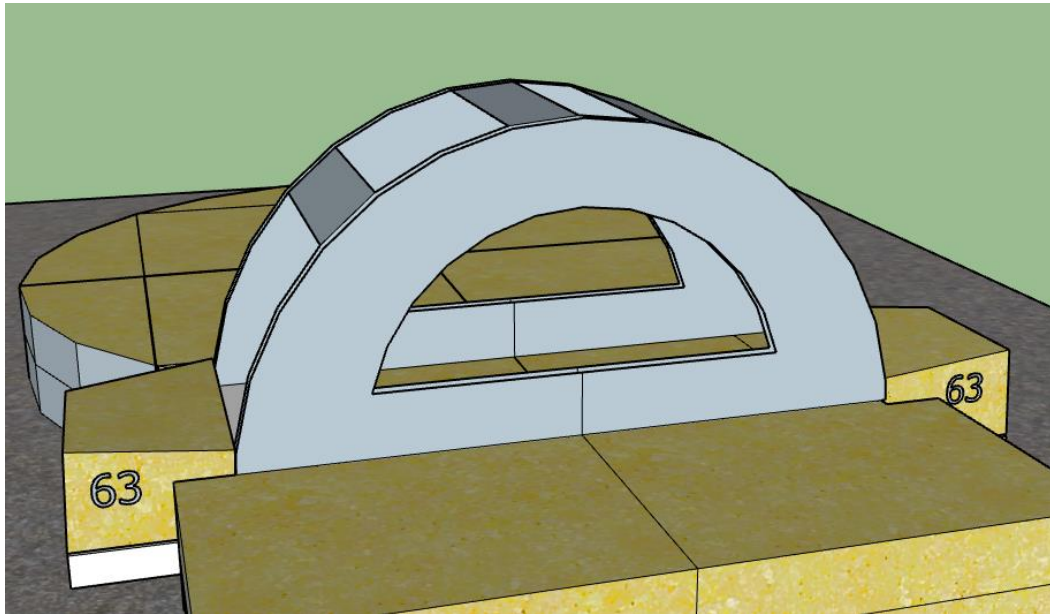

Door arch brick placement

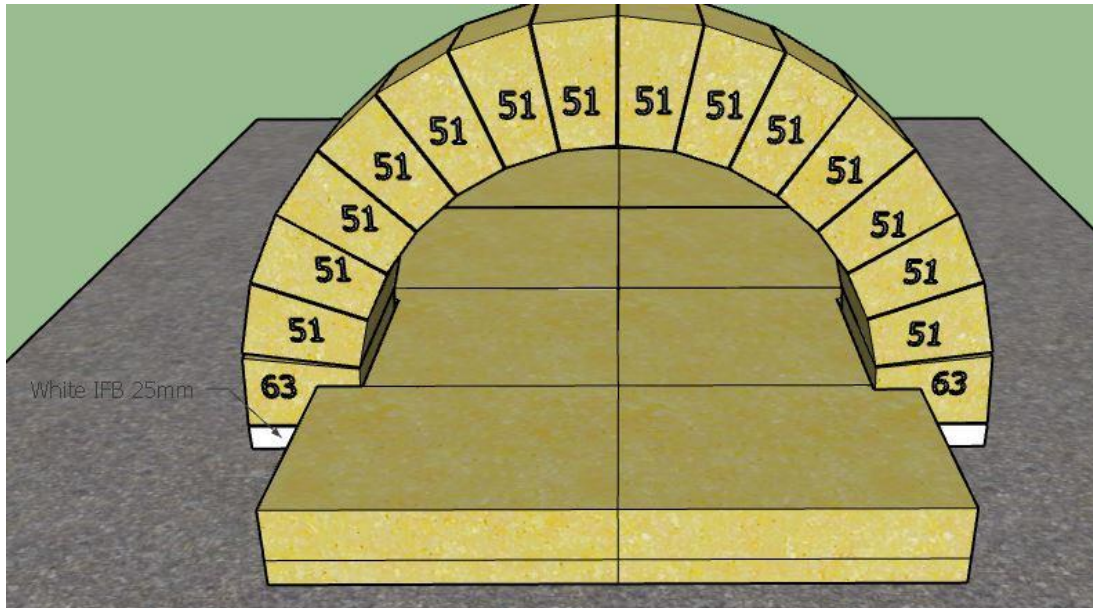

Your Door and flue arch templates have notches on them for each brick to fit perfectly. You will see this if you look closely, for each notch it's the correct brick to suit.

If you have found you have gone over a notch something is incorrect, go back and check your positioning. Remember using the airset mortar only 2-3mm joints

Door Arch completion

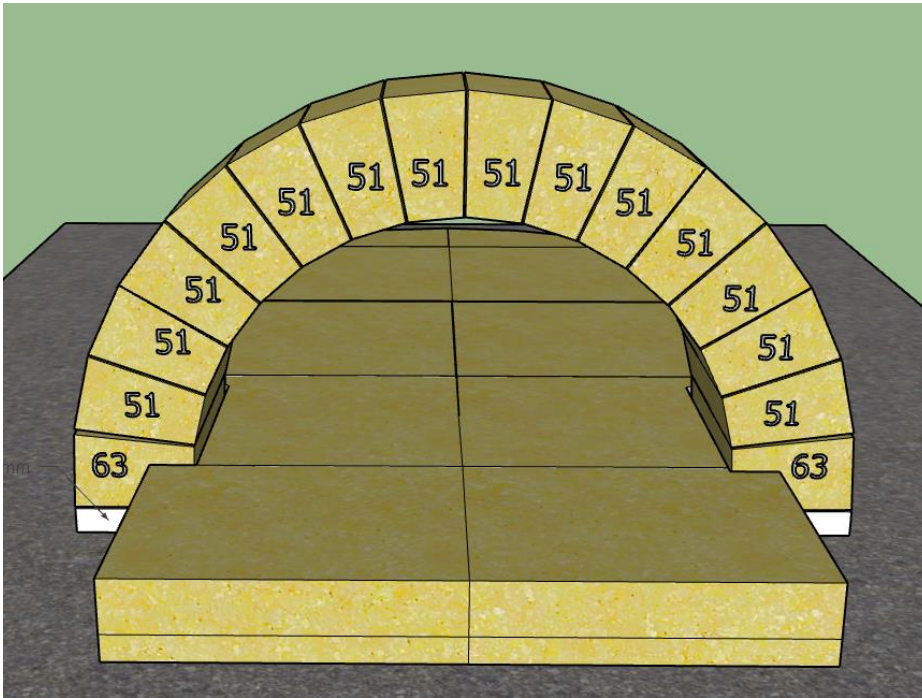

When you have finished the door arch leave the template in for at least an hour before removing it. You can also leave it in while building the chamber if you like.

Remember to knock out the spacers first to let the template drop before removing the template.

Clean any mortar joints as you go with a damp sponge NOT WET.

Chamber template assembly

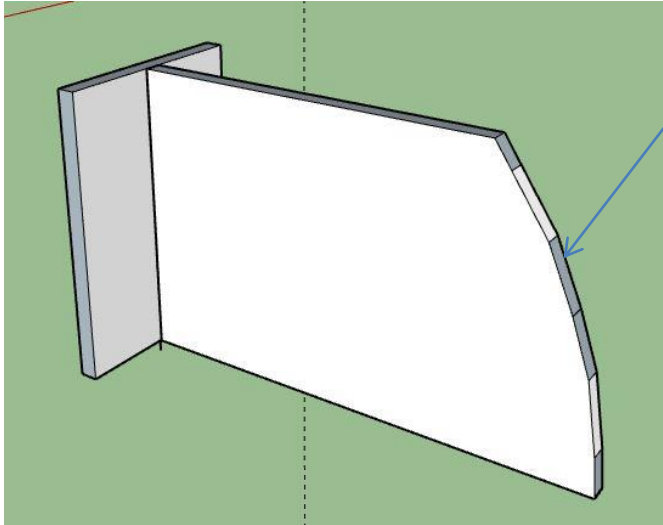

Your chamber template needs to be assembled.
It consists of 2 pieces and has notches for each brick layer

Find a thin gauge bullet head nail and insert into the centre and bottom of the template to form your pivot point Please note the length

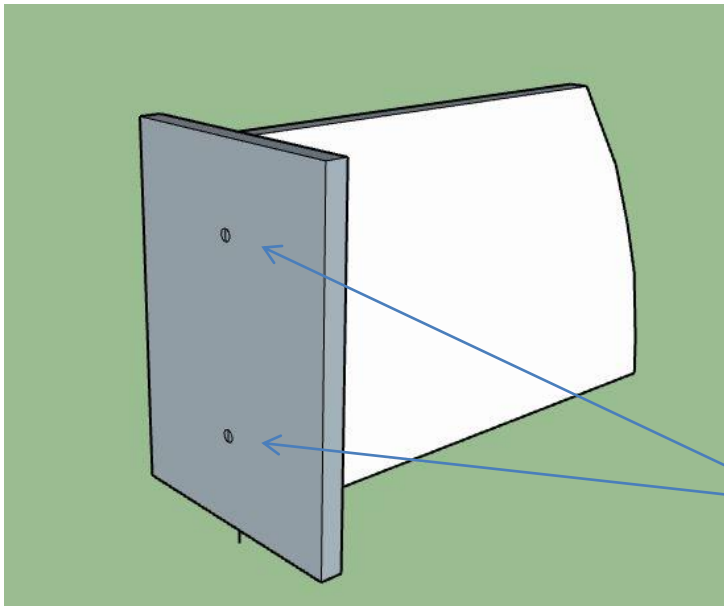
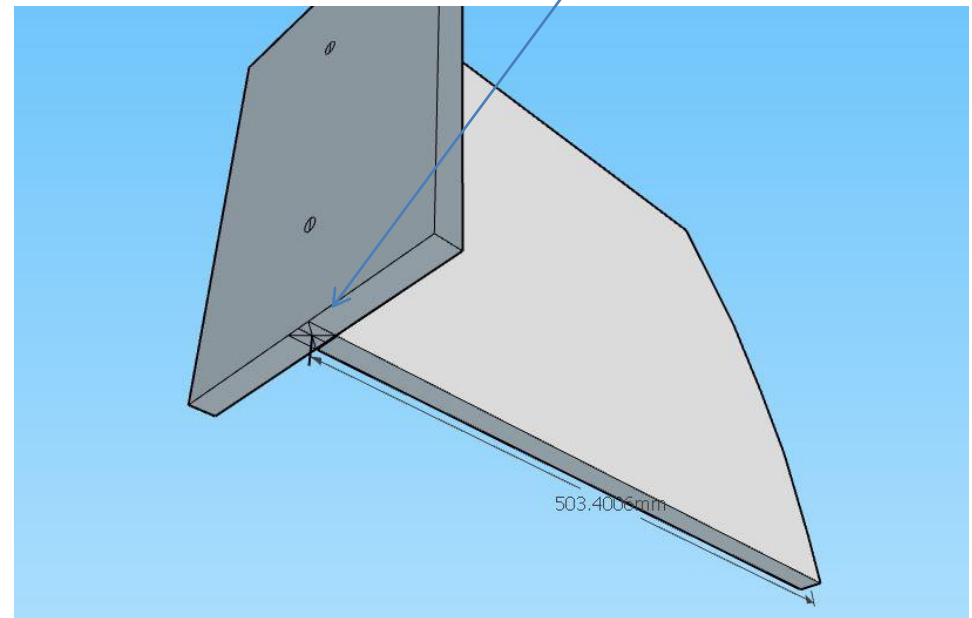

Join the template together with nails or screws from the rear in 2 places

Chamber template



The end result is it should look like this

Insert it into the centre of the floor tile and form a pivot point

Each notch in the template incorporates a layer of bricks The tool rotates so you know your on the right path

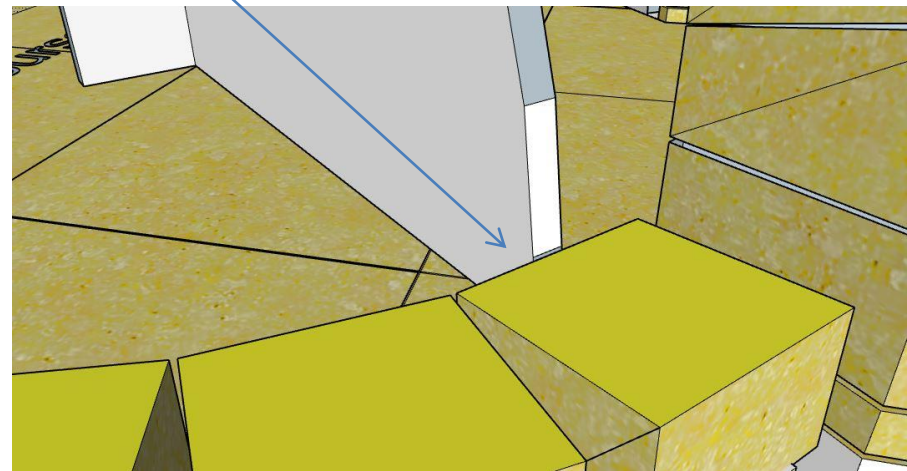
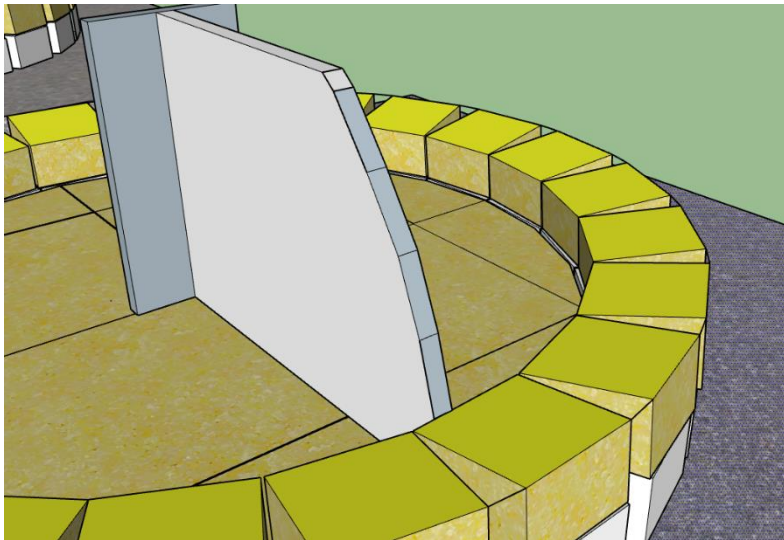

2nd chamber layer

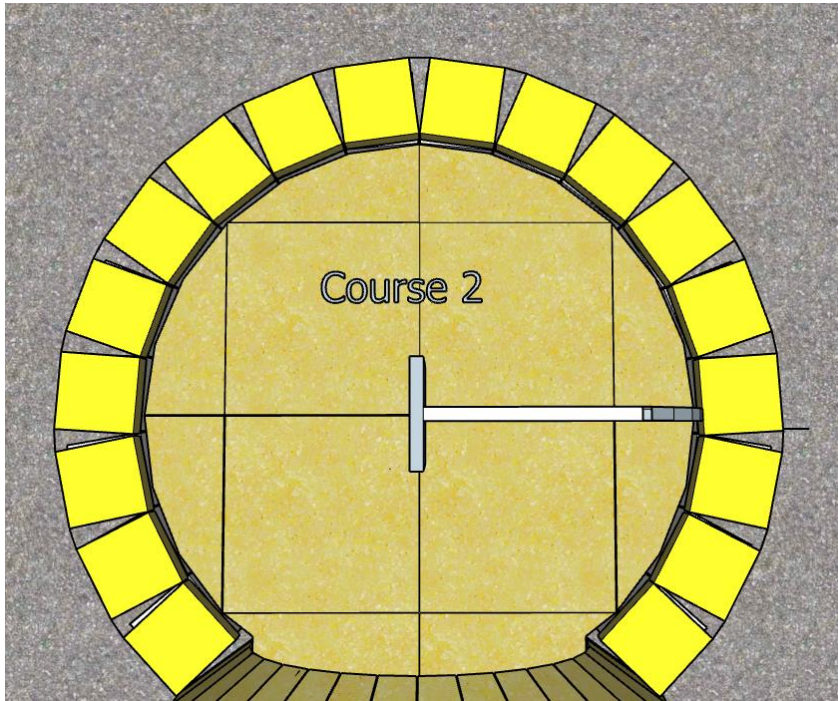

As listed in the first few pages of the instructions, the bricks To be used in the chamber are listed with the colour

Start your first layer directly ontop of the first layer using the (Yellow) 631 bricks mortaring them down in the following pattern.

When using the airset mortar its best to only butter the first 4-5 cms of the inside of the brick as the mortar is only best used up to 5mm . This applies to both under the bricks and the sides

The cement fondu mix is to be used on the exterior of the chamber bricks to fill in the larger gaps .

Remember to clean any internal mortar joints as you go with a damp sponge NOT WET. Particularly if you are laying the bricks over a number of days. It will make it easier to clean in later stages

3rd Chamber layer

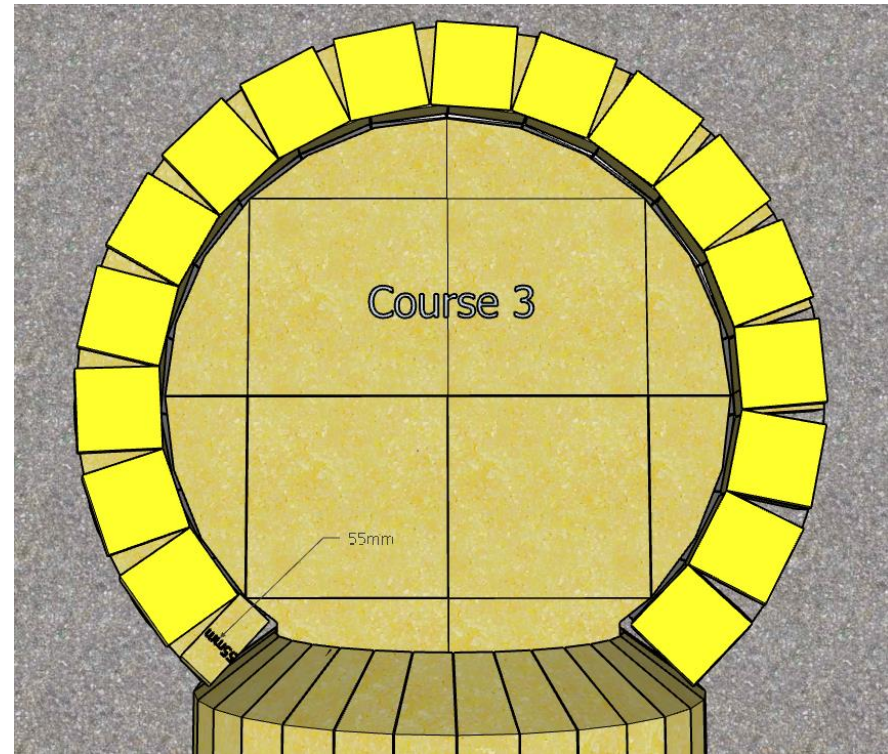

Using the chamber template as a guide from the centre of the oven rotate it around and lay your bricks in the pattern for the second layer Make sure you lean the bricks against the template guide to correctly set the angle

4th Chamber layer

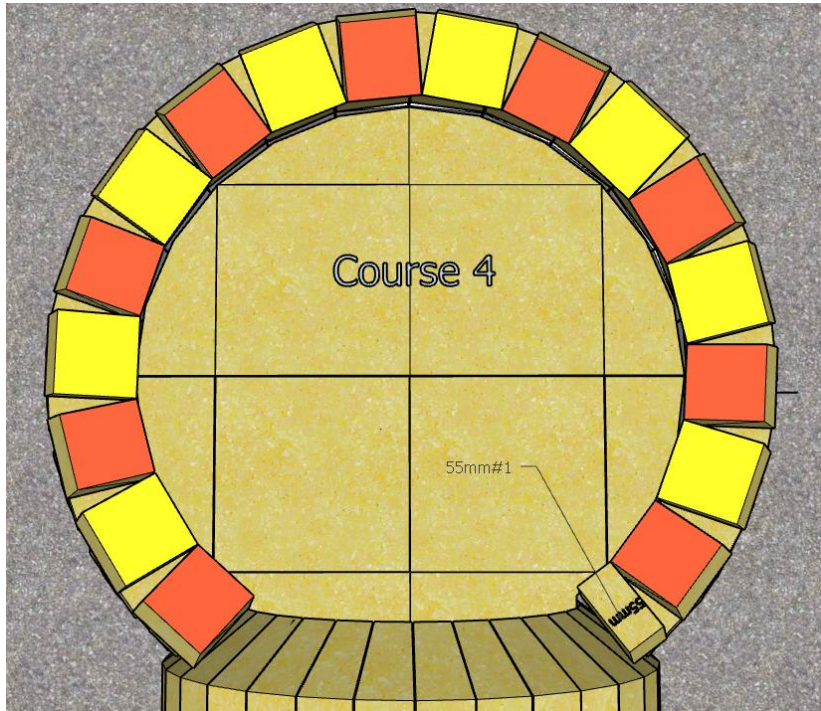

By now it's a good time to infill the rear of the chamber bricks with fondu – mix your batch and infill the rear of the chamber to strengthen it.

RED bricks are 632 bricks



5th Chamber Layer

Finish your 5th, Remember to follow the notches in the template for each row

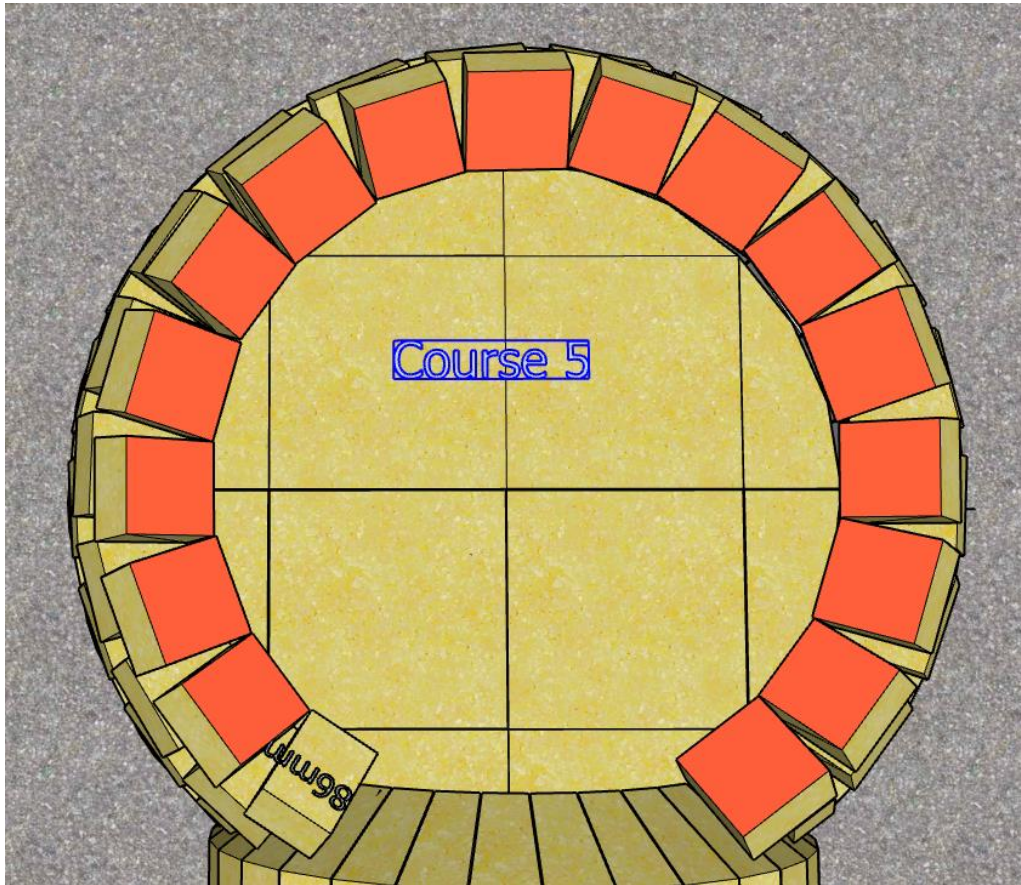

6th layer and PLUG

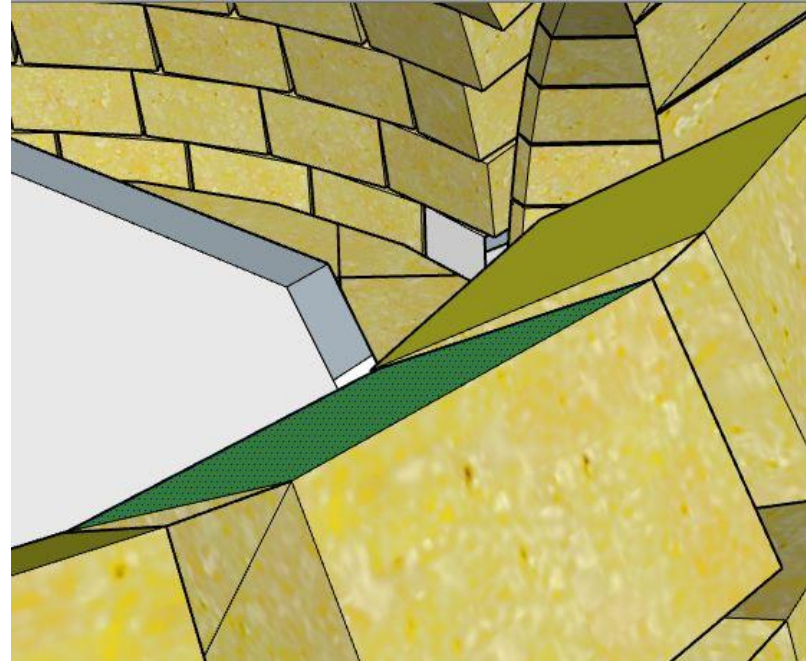
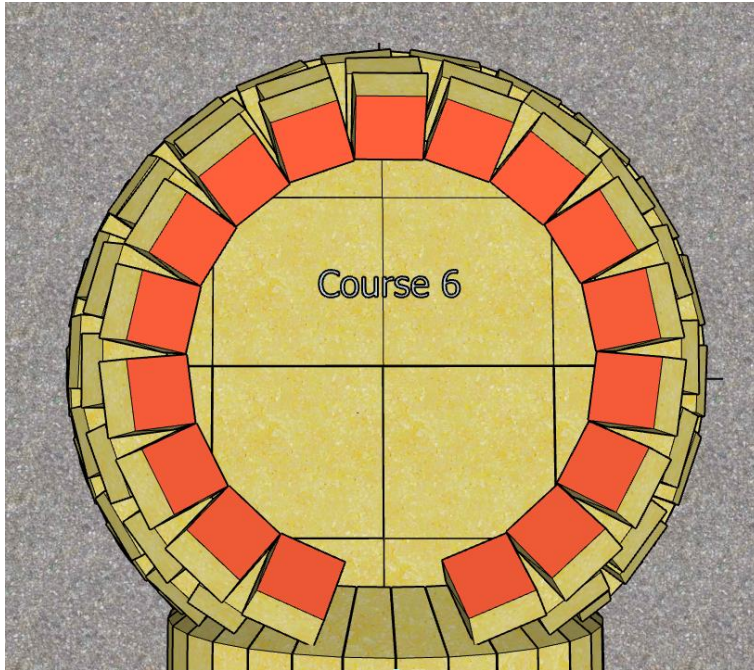

The 6th layer is your final layer before the plug to build the top of the oven.
Check layer 6 meet the top of the 2nd last notch in the template

Brick support

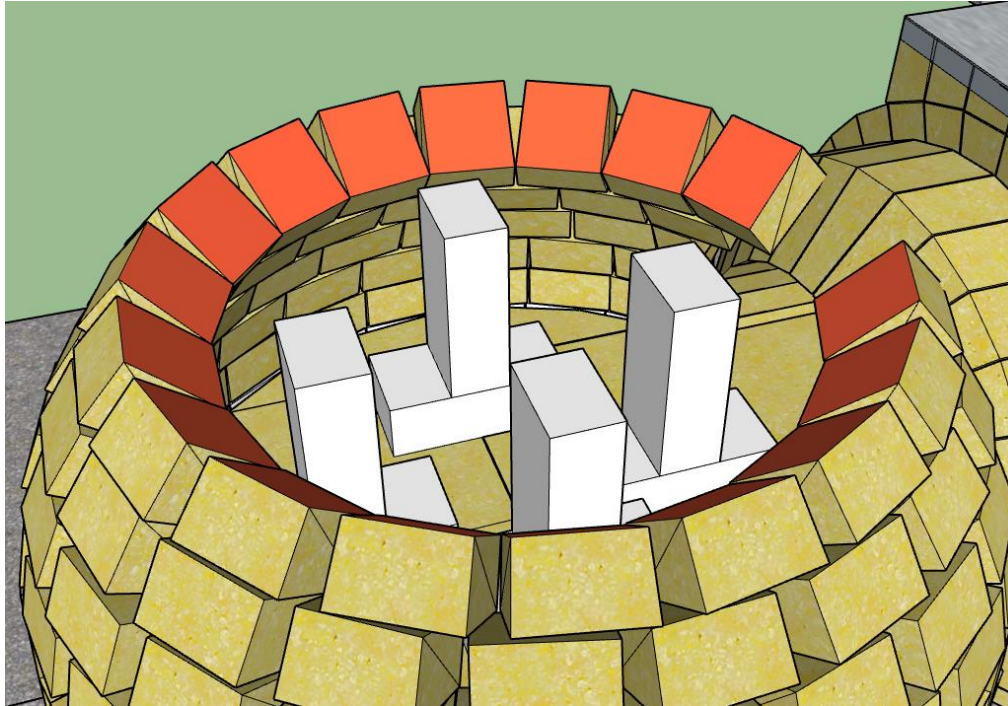

Using 8 common house bricks 230 x 115 x 75mm create 4 positions evenly spaced for the top templates to rest upon.

Placed a layer of black builders poly plastic covering the bottom of the oven and partially up the sides to catch the sand and debris when you knock out the bricks to make the clean-up easier

6th Layer and PLUG

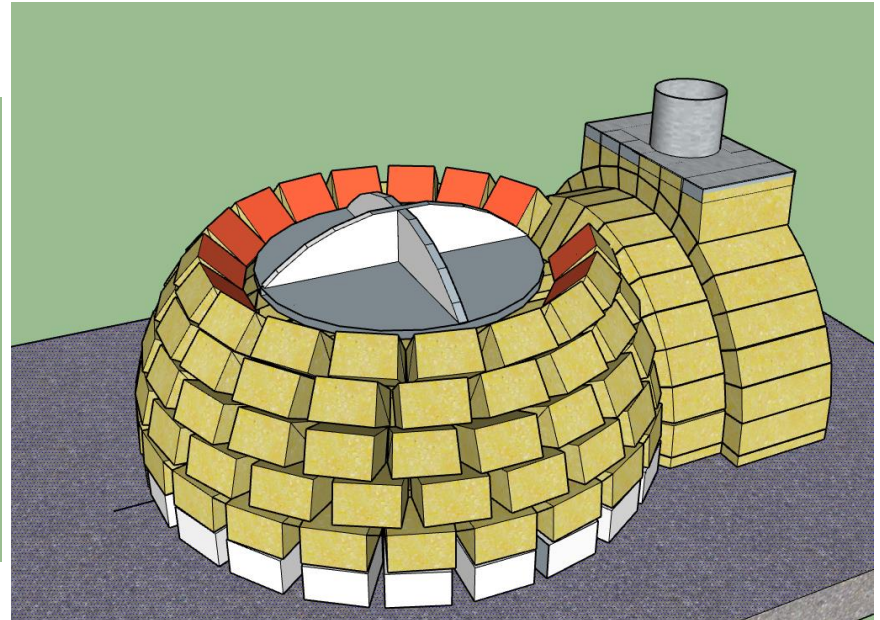
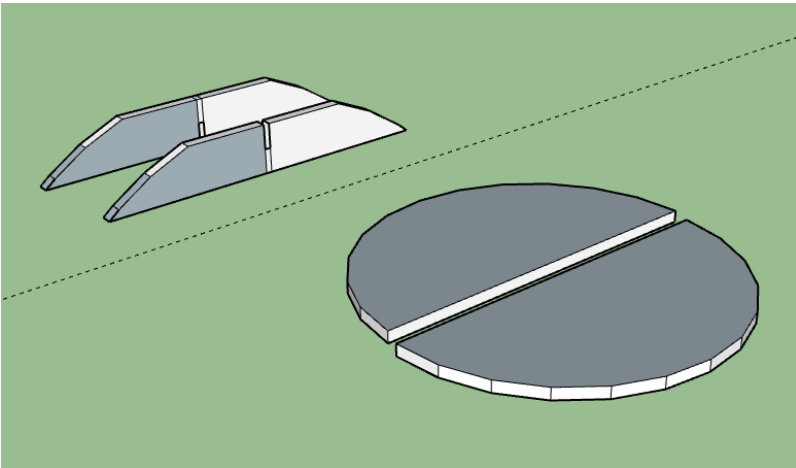

The top chamber templates simply interlock and are to be placed upon the 8 bricks with the centre line running from front to back.

Rotate the cross piece 45° so it is sat better across the joint in the 2 flat panels



7th Layer and PLUG

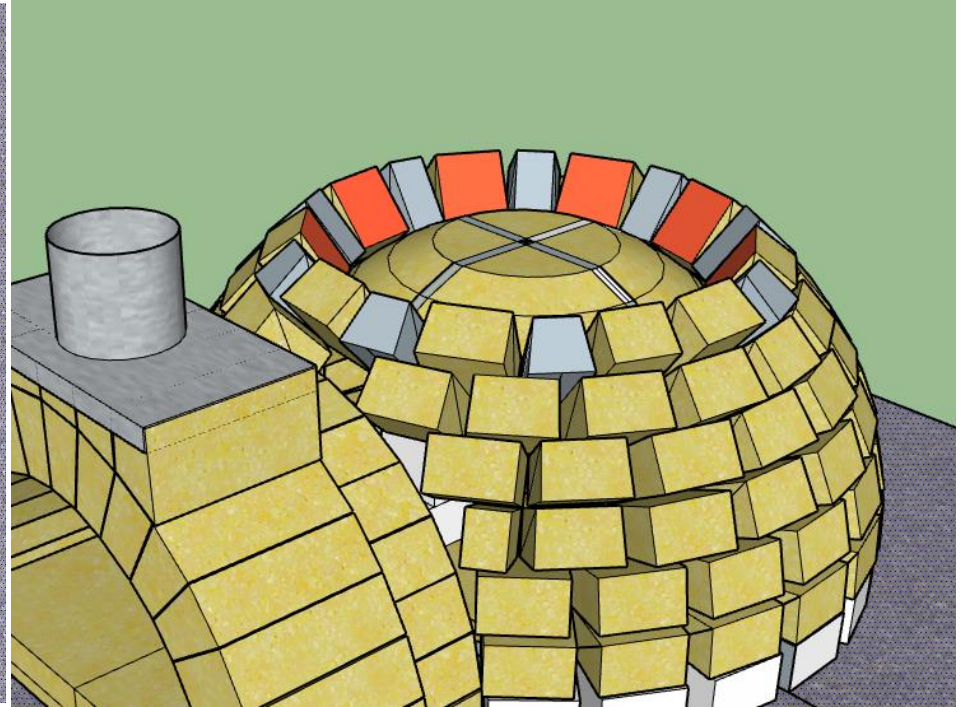
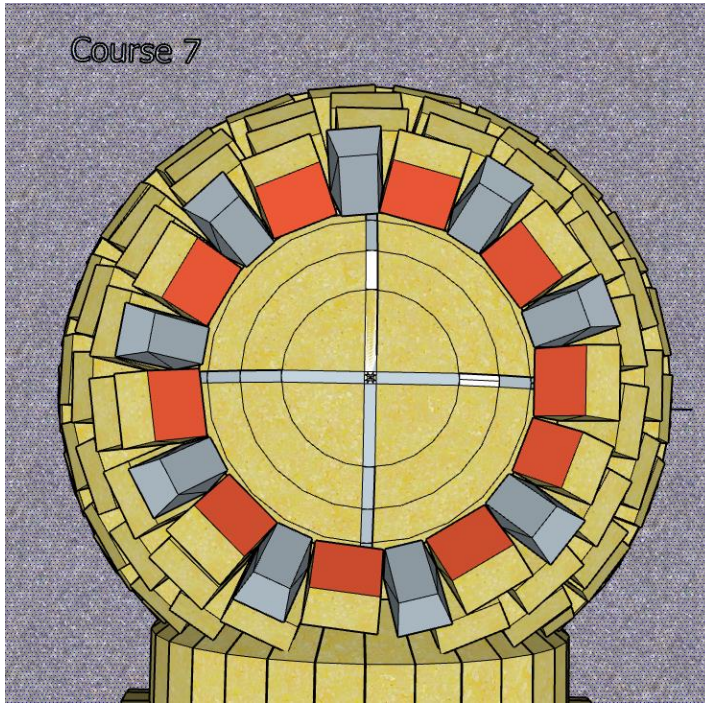

Start your 7th course following the course of timber template and meeting the first notch in the top template

Open your brickies sand and pour over the timber template to form the shape over the top of the oven keeping the notches exposed in the template. Place wet newspaper over the brickies sand as a separator so the sand doesn't stick to the mortared bricks

When putting in the template you can place few layers of newspaper under the plate to then wrap over the top of the sand. When I wet the newspaper it could massage the sand to make A nice dome and it contained the sand nicely

7th chamber layer 632 bricks

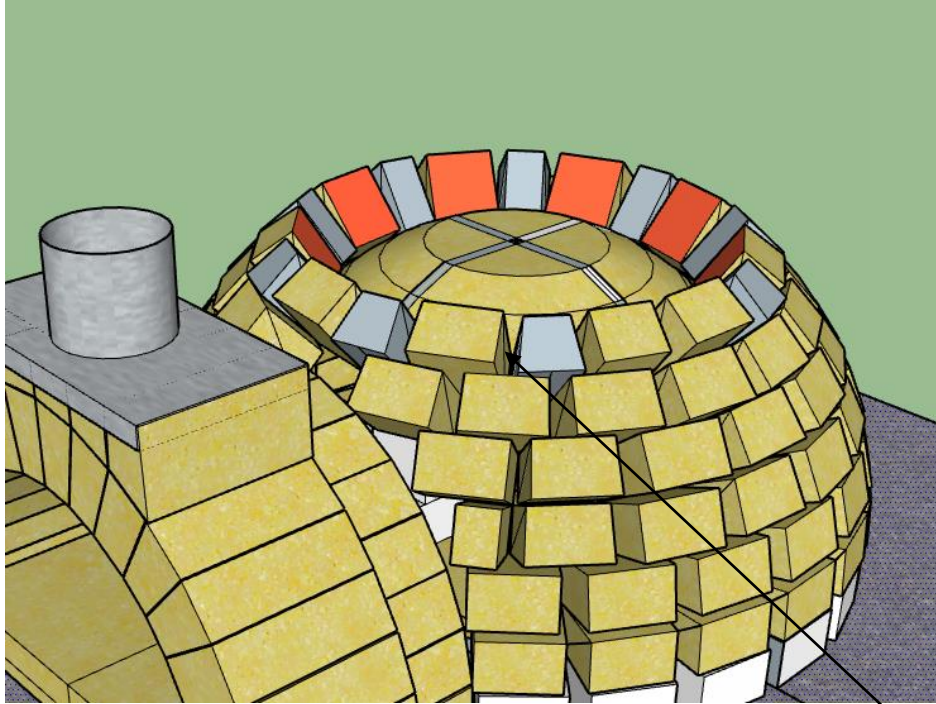

Using the airset mortar keep doing your 4-5mm internal mortar joints and fondu in between to lock the rear in and strengthen it. Follow the notches on the template for each row

8th & 9th Chamber layer

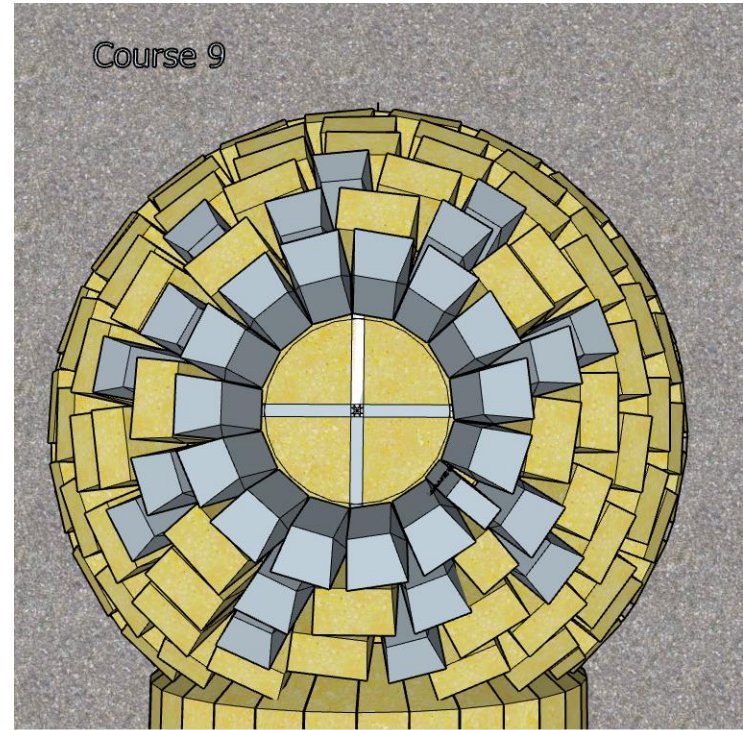
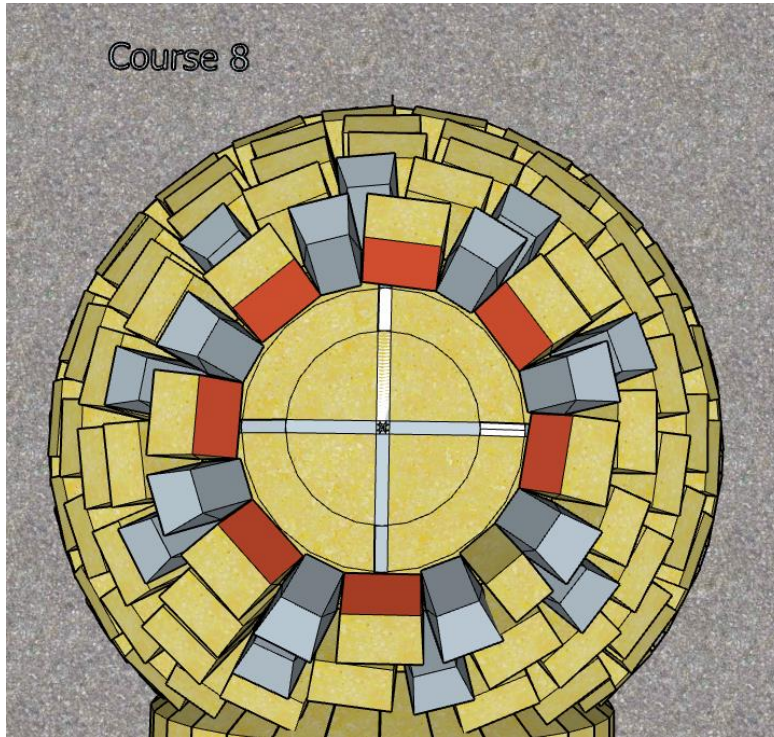

Final plug keystone in the top

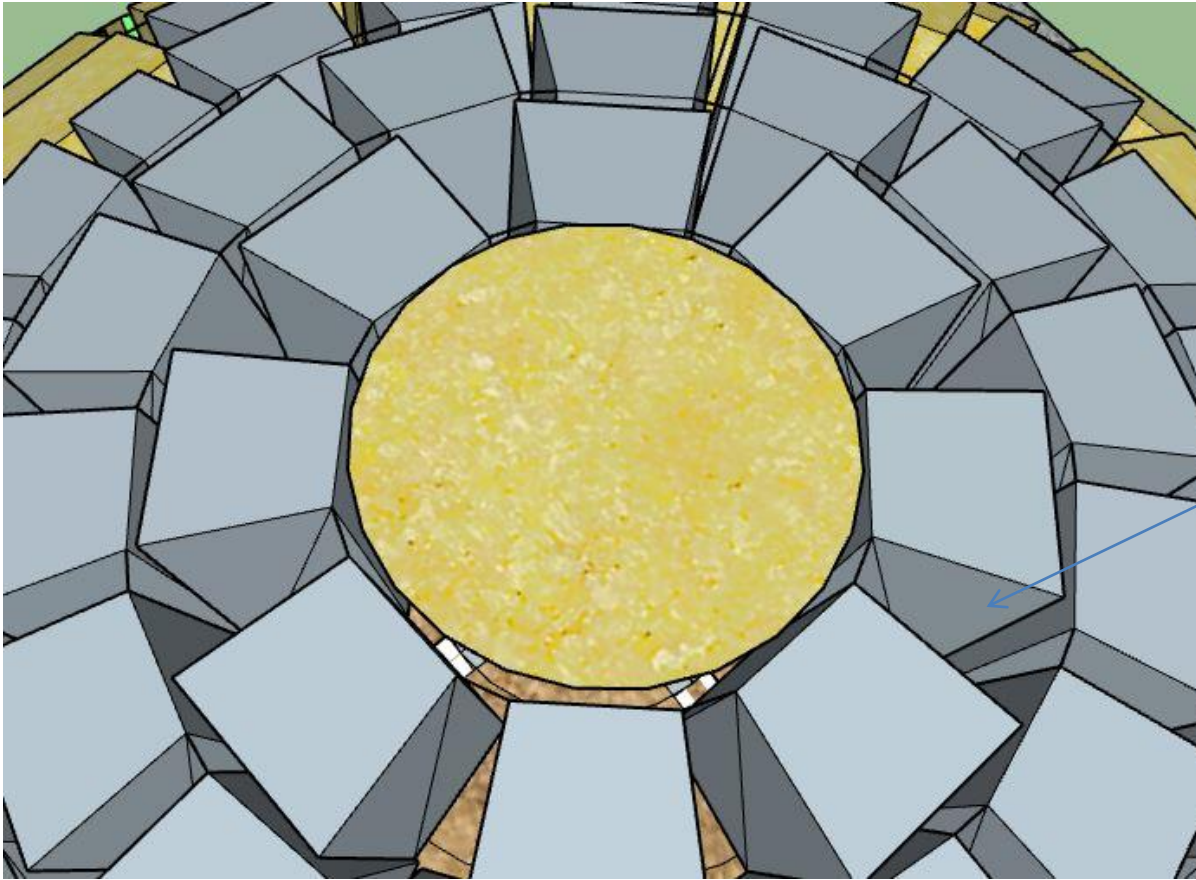

For the keystone mix some CAST 13 in a bucket and pour into the top to lock the entire structure together.

Do not forget the fondu mix in between the joints prior to pouring in the CAST 13 mix

Insider chamber



After leaving the sand plug in overnight (even longer for colder conditions) moisture free, Gently knock the bricks out holding the timber template in place. Start with the 2 front and then do the rear.

Clean the sand out and any debris and you should be left with the top left picture. You will have to venture inside the oven to clean the internal joints using a DAMP But not wet sponge. Too much water can cause weakness in the mortar.

Do this immediately after removal of the sand plug as the inside mortar will still be soft from the moisture in the wet newspaper and from the castable

****PLEASE BE CAREFUL CLEANING OUT THE OVEN !****

Building the flue arch

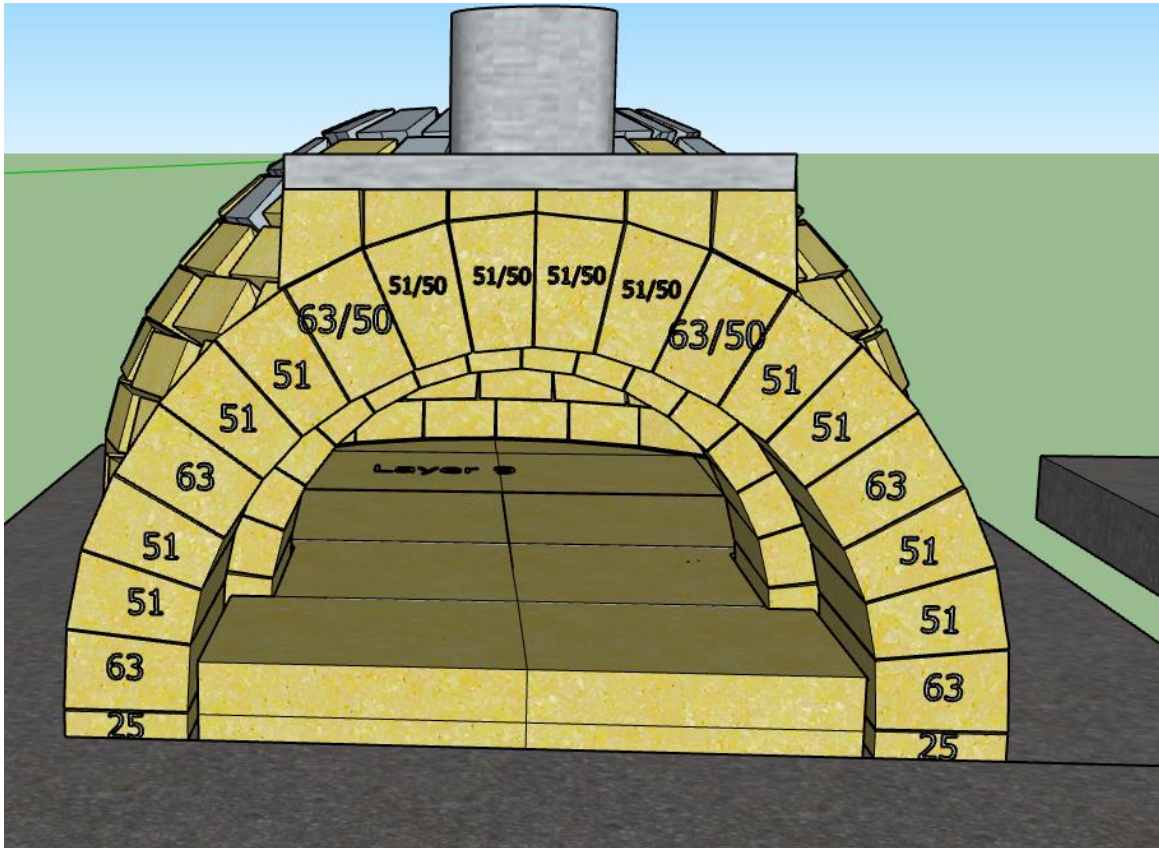

Screw the flue arch template together using 180mm timber battens and build your flue arch.

Remember your 2mm spacers

Building the top of the flue arch

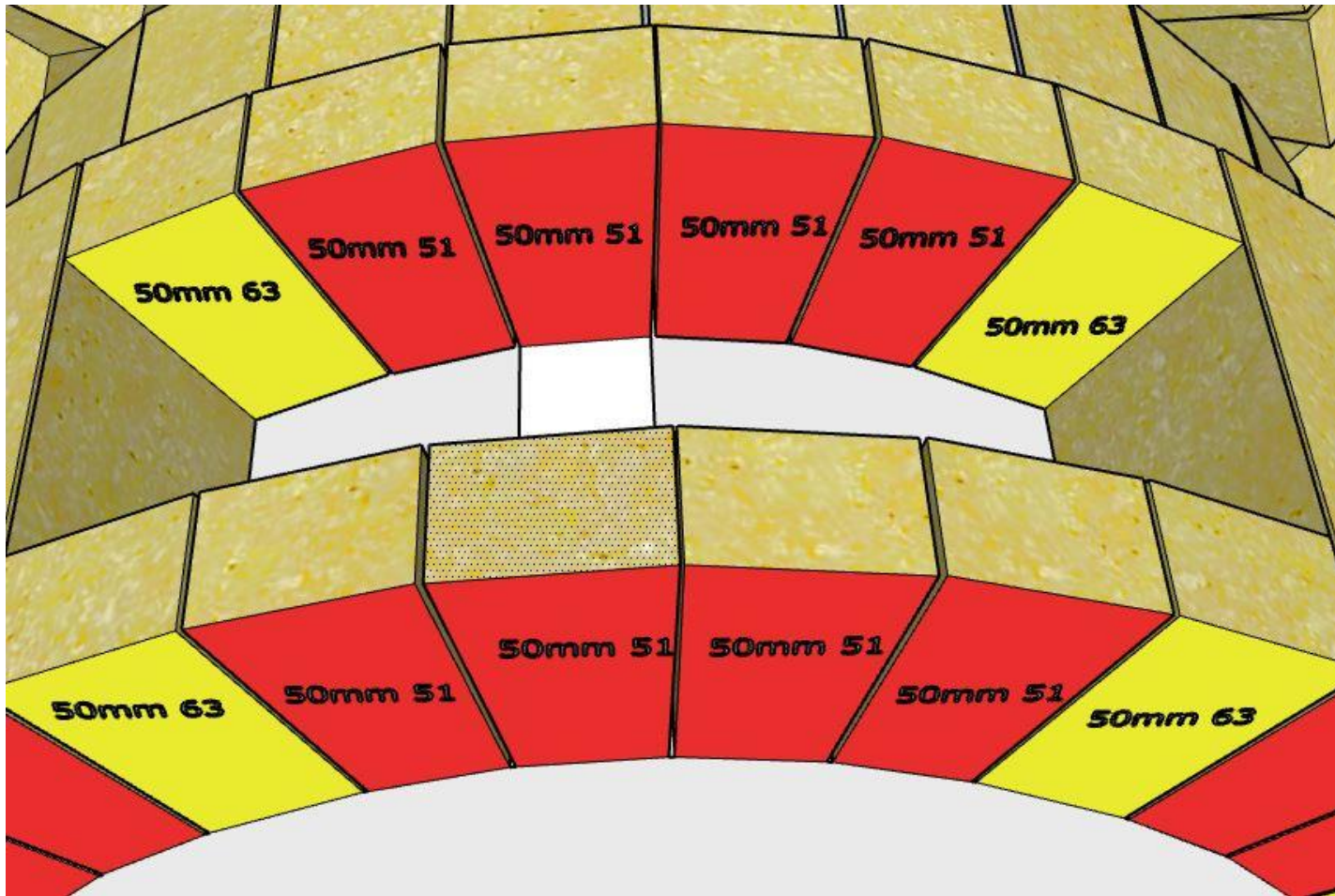

Brick trim and exhaust

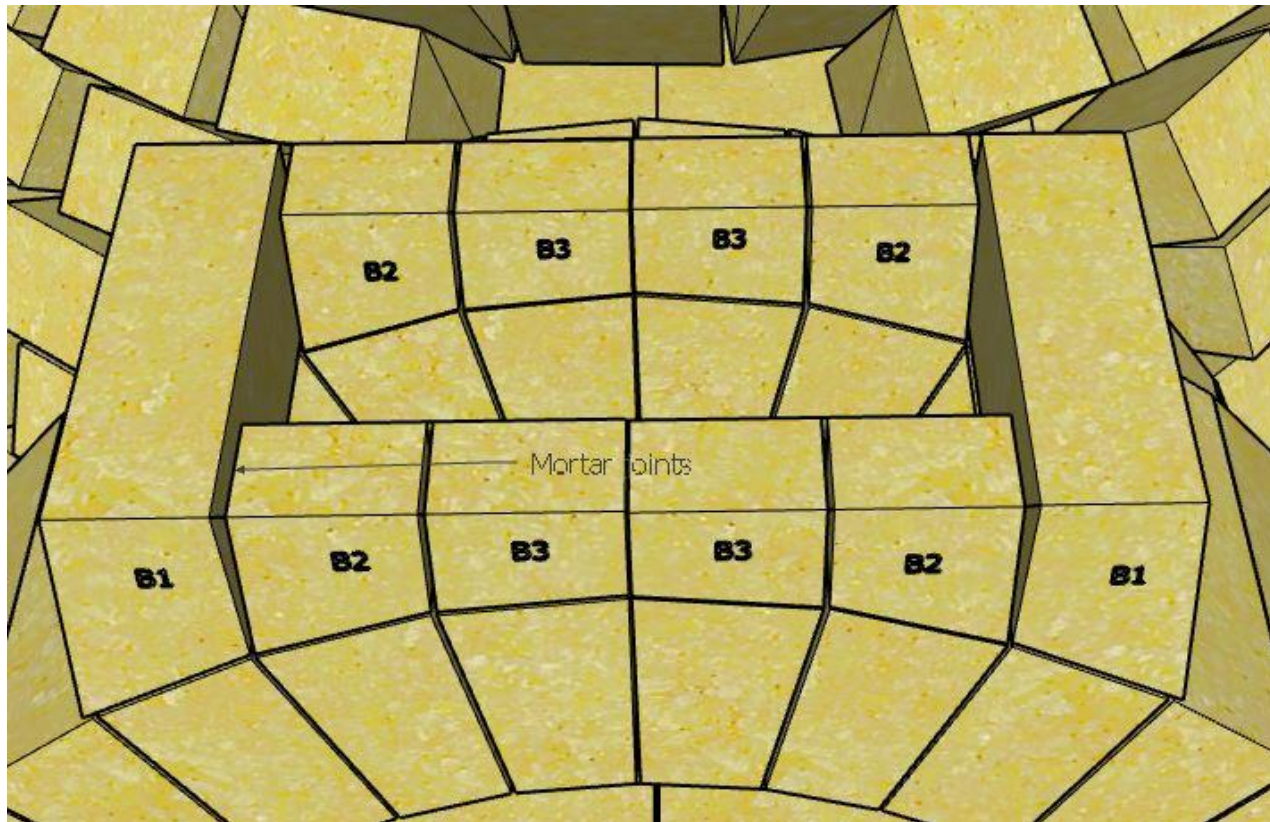

You can dry fit these first with the flue cap on top. Then Set the B1 bricks in place with the flue cap on top used the airset mortar, then using a flat edge set the b2s and b3s to get a nice finish.

Mortar flue exhaust cap

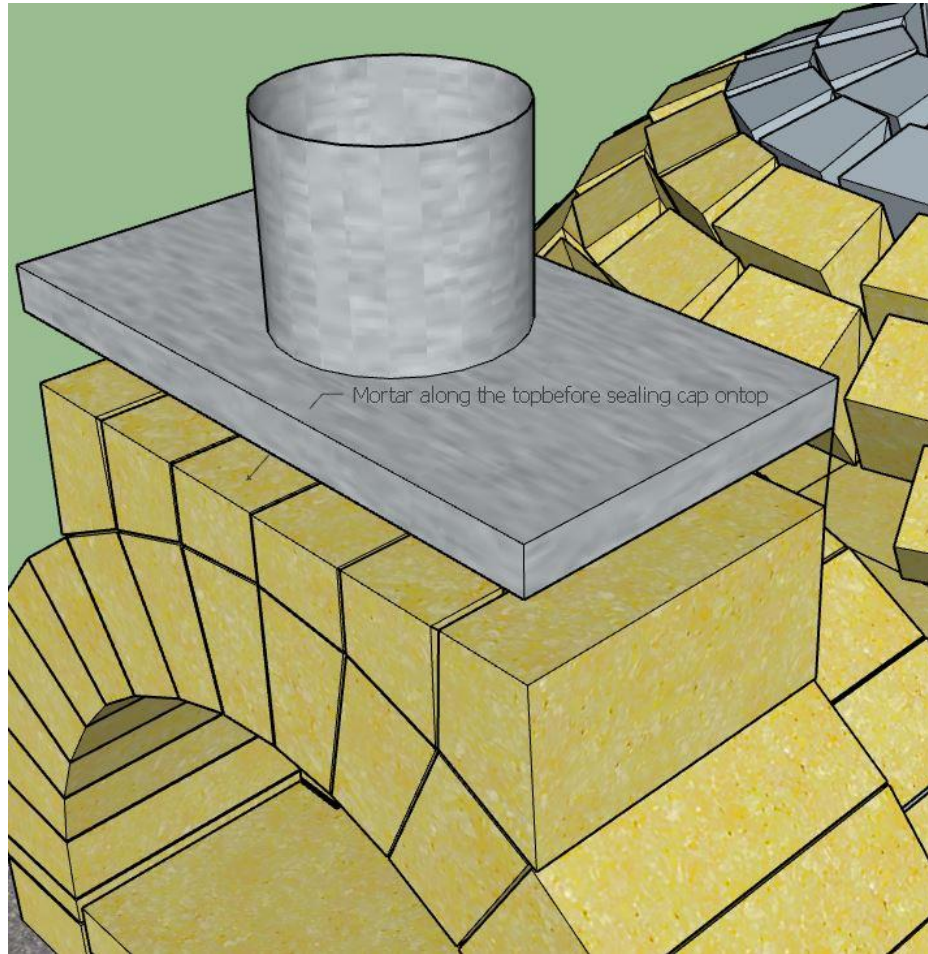

Use the airset mortar
to hold the flue in place

Weatherproofing

- Before you attempt to insulate the oven wrap the ovens chamber in Aluminium foil like a hot potato. You can do 1 layer or 5 layers the more the better. This stops the water from getting into the chamber.



Insulation and chicken wire



Ceramic insulation blanket can be irritable
And a dust mask and gloves must be worn
when handling this product....

Roll the ceramic blanket around the oven's base
and trim it so it hugs the chamber – cut pieces to
infill the areas of the chamber that you can see.
You should now not be able to see any of the
chamber.

2nd layer – roll it the opposite direction over the
top of the oven overlapping the joins and
continue to do this until a complete second layer
has been done.

Tuck the edges in around the flue arch



Roll your chicken wire around the base of the
oven. Punch in a concrete nail if needed and
secure it to the nail. Then use another concrete
nail behind the other side of the flue arch to pull
the wire tight. Then cut the wire to hug the
chamber and secure it down.

Render your oven

- **RENDER MIX = 8 Bags of 20kg BORAL SAND CEMENT + 10 handfuls of Boral builders clay**
- **When using the sand cement, mix 4 -5 - 20kg bags first with 6 handfuls of builders clay together and render the oven. Then with the final layer 3-4 - 20kg bags sand cement & 4 handfuls of builders clay. – If you don't find the BORAL brand of clay and cement its ok.**
- Once this is done mix your render (above) and form over the top to create a rough layer covering the chicken wire , If you see the chicken wire its not a worry, the first coat is the rough coat. Wait till the render is touch dry say 1hr. Then mix another lot of render to do the final coat. Make sure this coat covers the entire oven and no chicken wire must be seen. After you have finished the final coat wait till its touch dry and in a circular fashion use a damp sponge to give you a fine. Total render thickness should be about 30mm.
- Moisture is the ovens biggest enemy over time !!
- When the render has dried, usually 24hrs later the curing process must begin straight away. During the curing process no moisture must get into the oven otherwise you are reversing the curing. (curing instructions below). When the curing process is finished you must seal the rendered dome to prevent any moisture getting back in..
- Bondcrete can be used as well as part of the render. This mixes with water used to make the render and seals the oven. This is available from any local hardware store.



Moisture and curing

- Curing your oven.
- Recommended curing is good quality BBQ heat beads available at supermarkets and hardware stores. Heat them up on a gas bbq or fireplace until they are white around the edges. Place them in a metal pan and put in the centre of the oven keeping the oven at roughly 100 – 150 degrees- no higher. You can close the door entirely or keep the door ajar a few centimetres to let the air in to keep the heat beads going. The heat will dissipate quicker than usual as you're heating up a cold structure. PLEASE BE PATIENT as its protecting your oven for life. The heat beads are to stay in the oven for a **minimum** 24 – 48hrs (the longer the better) replacing the heat beads with new ones that are hot to keep the heat at 100 – 150 degrees. This pushes any moisture out of the oven and dries it for LIFE to prevent any issues. After the 48hr process then you can start to light a small fire in the metal pan keeping the flame very minimal. Push that into the centre of the oven. Slowly build the temperature up and add more timber until your fire is large.
- You will notice the ovens chamber changing colour and getting very hot. That's a good sign, its pushing and moisture out!! The back of the door will sweat as well. When the oven has changed to its dry colour and the door has stopped sweating your good to go.
- You can cure the oven to temperature and keep tending to it for the duration of the process or do it in small time frames say over a week. As long as the oven stays dry during the process you are good to go.
- Make sure after rendering and curing you keep the ovens rendered chamber out of the rain or from any moisture. If moisture gets in the oven before sealing you need to start the curing process again. The ovens chamber and render must be completely dry before sealing. Once this is done your ready to cook!

Moisture and curing



Sealing your oven

Your oven is now completely dry and you must seal it to prevent any moisture getting back in. We recommend products.

Bondall or Boncrete liquid sealer

Remember to follow the sealant manufacturer's instruction on the tin and recoat after 12 months or so.

REMEMBER ONCE YOU HAVE CURED THE OVEN IT MUST STAY DRY INSIDE OR THIS CAN CAUSE THE OVEN NOT TO HEAT UP TO TEMPERATURE AND CRACKING

Firing and maintenance

- **First firing**
- Upon your first firing please remember your heating up a structure this takes time. Light a small fire on the floor cooking tiles just inside the door archway at 6 o'clock so its receiving sufficient oxygen to become larger. After you have a large fire inside the door arch or middle of the oven then move the fire to either 3 o'clock or 9 o'clock inside the oven up against the chamber wall. The flame needs to travel the entire length of the chamber to heat the other side of the oven. Your chamber will turn black on the inside. This is because the carbon from the timber is burning off and the oven is NOT hot enough. When you have a large fire inside the oven for a long period of time you will notice the chamber in areas start to turn white. This means the oven is heating up. Once the oven turns 75% white or 100 % white your oven is hot enough to cook pizza !
-
- To maintain this heat you will have to keep stoking the fire with timber to keep the temperature up.
- Please note the door on the oven is not to be used at any stage upon the firing up and cooking. It is only meant to be used to keep the heat in overnight or between use.
-
- After you have used the oven and it is hot you can leave the fire in the oven and close the door. The oven will eventually cool down within 24 – 48hrs. To clean the floor of the oven simply scrape the floor to remove any food and scrape with a wire brush. Once the oven has cooled down you can take the Ash out and gently wipe the floor clean with wet, hot cloth.
-
- **Maintenance of your oven.**
-
- If you notice small hairline cracks in the oven, not to worry it does happen. There are many reasons for this.
- Every 6 months add a sealer to the ovens chamber to help protect it from any moisture re-entering the oven.
- If your stainless steel front starts to lose a little paint, just spray some touch up paint on it to keep it looking great.